



product catalogue

SAVE
MONEY, WATER
ENVIRONMENT & TIME
7 DAYS
BETWEEN
WATERING

plantscape 

part of idverde 

Rented | Planted | Watered | Purchased



once a week watering, WOW!

Plantscape® genuine once-a-week self-watering eco-friendly planters

In the competitive market of floral displays it has been stated as a matter of fact by some companies that their self-watering planters only need to be watered once a week. Even though this may sometimes work, as many customers have found out to their detriment, during dry or hot spells this isn't always the case and plants will require a larger water source to avoid damage or survive.

Well Plantscape® have now officially done just this and have been working with designers and engineers for a number of years to come up with a genuine once a week watering solution. After much hard work and testing since 2010 Plantscape® are pleased to announce that [genuine once a week watering is here!](#)

Hanging baskets, Holostar lamp post planters, Barrier Baskets, Window Boxes and floor standing planters have been re-designed and tested to create the world's first real and fully functioning once a week self-watering planters.

These are products that will help Councils and organisations of all shapes make considerable savings by reducing their maintenance and watering overheads by a considerable amount and

Benefits

- Genuine once a week watering
- Reduced carbon foot print and water wastage
- All round money saving
- Made from recyclable materials

in these times of austerity that can only be a good thing. Of course we must not forget the reduced impact on the environment as water wastage is reduced and the effect on the carbon foot print is cut in half by reducing road travel by 50% and thus reducing fuel bills and carbon emissions. This can only be a good thing.

These Plantscape® [genuine once a week self-watering planters](#) will give true meaning to the statement, "work smart not hard" whilst saving money and the environment at the same time. Beautiful floral displays with half the hassle! What's not to like?

So the question really should be, not whether you would want to try these new and ground breaking planters but whether you can really afford not to.

Please feel free to call us and speak to one of our friendly sales staff who will provide you with the information you require to make the right choice. We have done the hard work so you don't have to and we look forward to the possibility of speaking to you soon. Please Note: only available for outright purchase products



about us

As the UK's largest, most successful suppliers of hanging baskets and floral features, we pride ourselves on delivering a service that is unbeatable on price and value every time.

Plantscape's easy care, self-watering planters provide vibrant and lively colour in various public places, such as:

- Shopping Malls, Town and City Centres
- Railway and Bus Stations, Ports, Airports and Ferry Terminals
- Civic Buildings, Office Receptions and Hospitals
- Hotels and Restaurants
- Shows and Exhibitions

our services

At Plantscape® our design policy aims at minimum maintenance, which always provides best value. Not simply manufacturers of products, our success lies in our commitment and ability to offer the full service.

Here are some examples of what we offer:

- Our planters can be purchased on their own or fully planted
- With our wide choice, we have the solution to all your needs from a simple one-off floral feature to a comprehensive package with maintenance
- Our year round service means delivery, installation and collection at the seasons end, over the winter we'll store your planters and exchange them for winter flowering baskets



**PLANTERS
AVAILABLE TO BUY
EMPTY OR TO RENT
FULLY PLANTED**

contents

horizontal containers	08 - 15
elevated baskets	16 - 25
box clevers	26 - 27
interlocking bedding planters	28 - 29
floor-standing planters	30 - 43
educational planters	44 - 47
tree planters	48 - 49
promotional planters	50 - 51
pedal park	52 - 53
planter seats	54 - 55

wooden planters	56 - 63
bespoke planters	64 - 65
castaway® planters	66 - 67
welcome signs	68 - 71
basket trees	72 - 75
christmas trees	76 - 77
customer imagination / colour schemes	78 - 79
the four seasons	80 - 81
lamp post testing	82 - 83



the perfect location...

We are ideally located in the heart of Britain enabling us to serve the entire UK with a speedy and efficient delivery to any location. Made even easier with the motorway system at our doorstep.

Plantscape® have recently heavily invested in developing their offices and production headquarters. With 70,000 sq ft of greenhouse space and 15,000 sq ft of warehouse we have enough space for over 20,000 planters and over £150,000 worth of stock, so rest assured that even the largest order can be fulfilled quickly and efficiently. Thus helping Plantscape® remain the largest supplier of floral features in the UK.

But it doesn't stop there. With the help of the Internet we are now able to work with businesses all around the world, including USA, Romania, Austria and Ireland. We know no blooming boundaries.



perfect plants in important places...

It's been a busy 12 months for Plantscape® during which we've supplied:

- In excess of 10,000 summer planters and more than 3,000 of our unique solar powered Christmas trees
- Hundreds of colourful floral planters which have won awards as part of the In Bloom competitions
- Countless architects, landscapers and VIP customers looking for bespoke planters to finish off their building projects

perfect solutions at a moment's notice

When you are pushed for time rapid response planters are a perfect resolution. Plantscape® have a range of decorative planters all ready to go whenever you are.

Our flexible rental agreement ensures that we will deliver and install these rapid response planters and collect them the day after the event, weekend or whole season. The choice is yours!

Additional key points about this unique service include:

- Plantscape® grow the plants at our own nursery and bring them to you in full bloom
- Huge selection of stock planters available
- No capital outlay
- Even if it does not feature in our catalogue we will try to match your specific requirements
- Delivered and installed by specially trained staff at a time and location to suit you

make it your own...

Anything is possible with our truly bespoke service. Plantscape® have everything you need to project your own identity and message from customised labels, plaques, mouldings and custom colours. We can incorporate your name, logo or crest to any product through moulds in graphics and vinyl plaques.

All the personalisation ranges are made to order to suit your own individual needs, allowing you to create a personal and sometimes informative touch to busy or quiet public places.

Get in touch

Whatever your looking for, we're sure you'll find it in the many innovative and practical solutions available in our brochure.

To order or for a free, no-obligation demonstration on any of our products, call us now on:

0330 555 0121 (option 4)
or email: info@plantscapeuk.com

We accept all major credit and debit cards



SAVE
MONEY, WATER
ENVIRONMENT & TIME
7 DAYS
BETWEEN
WATERING



**PLANTERS
AVAILABLE TO BUY
EMPTY OR TO RENT
FULLY PLANTED**

barrier baskets

making your highways bloom!

Plantscape's eye-catching Barrier Baskets are the perfect solution to brighten your streets and highways. Incorporating a special low maintenance feature for easy watering and feeding, their unique design means they can go for days without watering.

Available in two standard sizes and in a variety of colours, our baskets come with galvanised bracket fixings to enable mounting on the top rail of central reservation barriers or railings - any size, round or square. Our brackets come in three standard sizes but our bespoke service means that if none of these sizes fit your barrier we can make them specially to suit.

all year round planting

The use of our insert liners means easy planting in winter or summer. Utilising our liners, plants can be grown in the nursery becoming established before being changed over to give an immediate change of scenery. Insert liners can be made secure by using our simple security bracket which slides down inside each liner and is secured by a cap head screw.

Benefits

- Easy accessible holes for watering & feeding
- Fixes onto a variety of railings & barriers
- Insert liners allow all year round planting
- Liner security bracket available
- Two standard sizes 680mm & 1250mm
- Available in a variety of colours



Use of insert liners allows plants to become established in our nursery giving an immediate burst of colour

Barrier Baskets

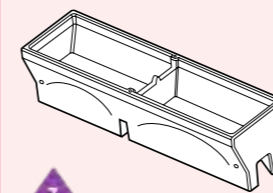

- Specification:**
- 1250mm x 360mm x 360mm
 - Water reservoir capacity 40 litres
 - Compost capacity 40 litres
- Requires:**
- 2 fixing brackets
 - 2 insert liners (optional)



REF: PBB1250/CONTRACTOR

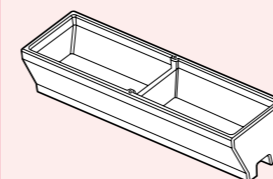

- Specification:**
- 1250mm x 360mm x 290mm
 - Water reservoir capacity 15 litres
 - Compost capacity 56 litres
- Requires:**
- 2 fixing brackets
 - 2 insert liners (optional)

REF: PBB1250

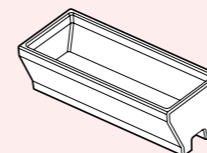

- Specification:**
- 680mm x 360mm x 290mm
 - Water reservoir capacity 8 litres
 - Compost capacity 31 litres
- Requires:**
- 1 fixing brackets
 - 1 insert liners (optional)

REF: PBB680

Optional Items

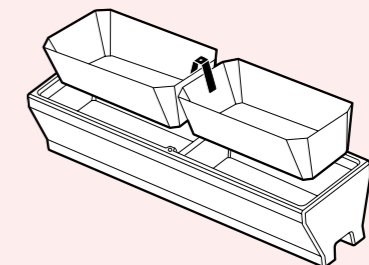

- Insert Liners:**
- 570mm x 260mm x 150mm

REF: PBB/INS

Please Note: All measurements and capacities are approximate

window boxes

bright cheerful and uplifting!

Low maintenance and extremely versatile, Plantscape's Window Boxes are not only ideal for fitting beneath your window sills, but they can also be securely fitted to walls, railings and signs using our brackets to add vibrant colour.

Available in four standard sizes and a variety of colours to suit your surroundings, these can also be supplied with a Box Clever in brushed stainless steel or powder coated finishes to hide your polyethylene planters.

all year round planting

Using our insert liners with your Window Boxes means easy planting in Winter or Summer. Utilising our liners, your plants can be grown in our nursery, allowing them to become fully established before adding them to your window box, to give an immediate change of scenery.



Options to mount to railings, street signs, window ledges, infact anywhere you want!



SAVE
MONEY, WATER
ENVIRONMENT & TIME
7 DAYS
BETWEEN
WATERING

PLANTERS
AVAILABLE TO BUY
EMPTY OR TO RENT
FULLY PLANTED

- Benefits**
- Fixes to window sills, walls & railings
 - Insert liners allow all year round planting
 - Four standard sizes 750mm, 1000mm, 1250mm & 1500mm
 - Box clever finishes available
 - Available in a variety of colours

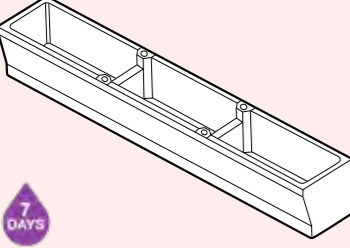
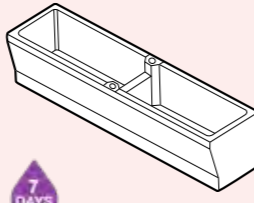
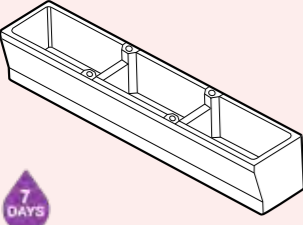
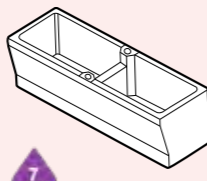
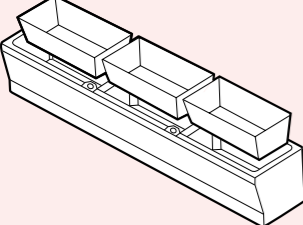
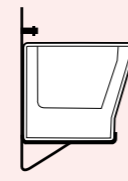
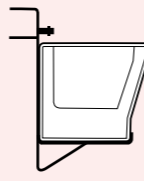
Window Boxes			
 <p>7 DAYS</p>	<p>Specification:</p> <ul style="list-style-type: none"> • 1500mm x 250mm x 230mm • Water reservoir capacity 35 litres • Compost capacity 35 litres <p>Requires:</p> <ul style="list-style-type: none"> • 3 Insert liners - 450mm x 185mm (optional) <p>REF: PWB1500</p>	 <p>7 DAYS</p>	<p>Specification:</p> <ul style="list-style-type: none"> • 1000mm x 250mm x 230mm • Water reservoir capacity 25 litres • Compost capacity 20 litres <p>Requires:</p> <ul style="list-style-type: none"> • 2 Insert liners - 450mm x 185mm (optional) <p>REF: PWB1000</p>
 <p>7 DAYS</p>	<p>Specification:</p> <ul style="list-style-type: none"> • 1250mm x 250mm x 230mm • Water reservoir capacity 25 litres • Compost capacity 30 litres <p>Requires:</p> <ul style="list-style-type: none"> • 3 Insert liners - 390mm x 185mm (optional) <p>REF: PWB1250</p>	 <p>7 DAYS</p>	<p>Specification:</p> <ul style="list-style-type: none"> • 750mm x 250mm x 230mm • Water reservoir capacity 20 litres • Compost capacity 18 litres <p>REF: PWB750</p>
Liners		Brackets	
 <p>Specification:</p> <ul style="list-style-type: none"> • 390mm x 185mm x 120mm • 450mm x 185mm x 120mm <p>Requires:</p> <ul style="list-style-type: none"> • 2 insert liners - 1000mm window box • 3 insert liners - 1250mm & 1500mm window boxes <p>REF: PWB/INS390 REF: PWB/INS450</p>	<p>1</p>  <p>REF: PWBWALLBRKT</p>	<p>2</p>  <p>REF: PWBSPCLBRKT</p>	

Please Note: All measurements and capacities are approximate

grow bag containers

ideal for summer or winter!

Plantscape's versatile Grow Bag Containers are perfect for placement on balconies, windows and bus shelters, offering easy planting in summer or winter.

Available in two standard sizes and a wide range of colours, they incorporate a built in water reservoir system which means they can go for days between watering - a low maintenance and thoroughly eye-catching solution!



Grow Bag Container mounted onto a wall - security brackets available

Benefits

- Fixes to balconies, windows & bus shelters
- Holds 1 standard grow bag
- Available in a variety of colours

Grow Bag Containers

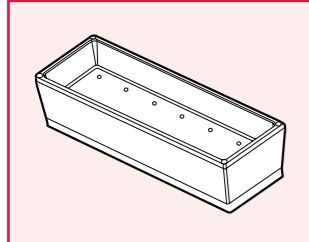
	<p>Specification:</p> <ul style="list-style-type: none"> • 780mm x 350mm x 190mm • Water reservoir capacity 25 litres • Compost capacity 36 litres • Holds 1 standard grow bag <p>REF: PGB780</p>
	<p>Specification:</p> <ul style="list-style-type: none"> • 1265mm x 540mm x 240mm • Water reservoir capacity 32 litres • Compost capacity 74 litres <p>REF: PGB1265</p>

Please Note: All measurements and capacities are approximate



SAVE
MONEY, WATER
ENVIRONMENT & TIME
7 DAYS
BETWEEN
WATERING

PLANTERS
AVAILABLE TO BUY
EMPTY OR TO RENT
FULLY PLANTED

case study

broxbourne borough council

We won gold when we were approached by Broxbourne Borough Council to provide colour and vibrancy to their streets for the 2012 Olympics.

Broxbourne were proud to be hosting the White Water Canoe Slalom competition at the purpose-built, state of the art, artificial White Water Centre in the Lee Valley Park. 82 Athletes were competing in the White Water Canoe Slalom competitions for four Olympic gold medals as part of the London 2012 Olympic Games and Plantscape® were proud to be at the centre of the excitement, and ultimately play a part in the greatest sporting event in the world.

Our creative juices were allowed to flow with this project as Plantscape® were entrusted to develop the plant specification for both the summer and winter planters. They were all planted in our insert liners at our nursery and once established placed into the Barrier Baskets on site. Plantscape® supplied, watered and maintained 34 hanging baskets, 260 barrier baskets and 140 Holestair lamp post planters.

Plantscape's Barrier Baskets have a clever design and incorporate the special low maintenance features allowing for easy watering and feeding. Their unique design means that planters can go for days without watering.

If ever there was a case to prove how we like to go above and beyond for our clients, our contract with Broxbourne Borough Council would be first in line. Installation for the barrier baskets had to be done very early in the morning or at night to make sure there was no disruption to traffic. For a secure fitting, our bracket comes in three sizes and fit onto any standard railing and barrier and we had no issue with any vandalism during the entire summer.

Broxbourne Borough Council were over the moon with the planters and displays. They really made Broxbourne stand out as an Olympic site, giving Olympic visitors and passengers a delightful welcome, a fantastic stay and a warm farewell.

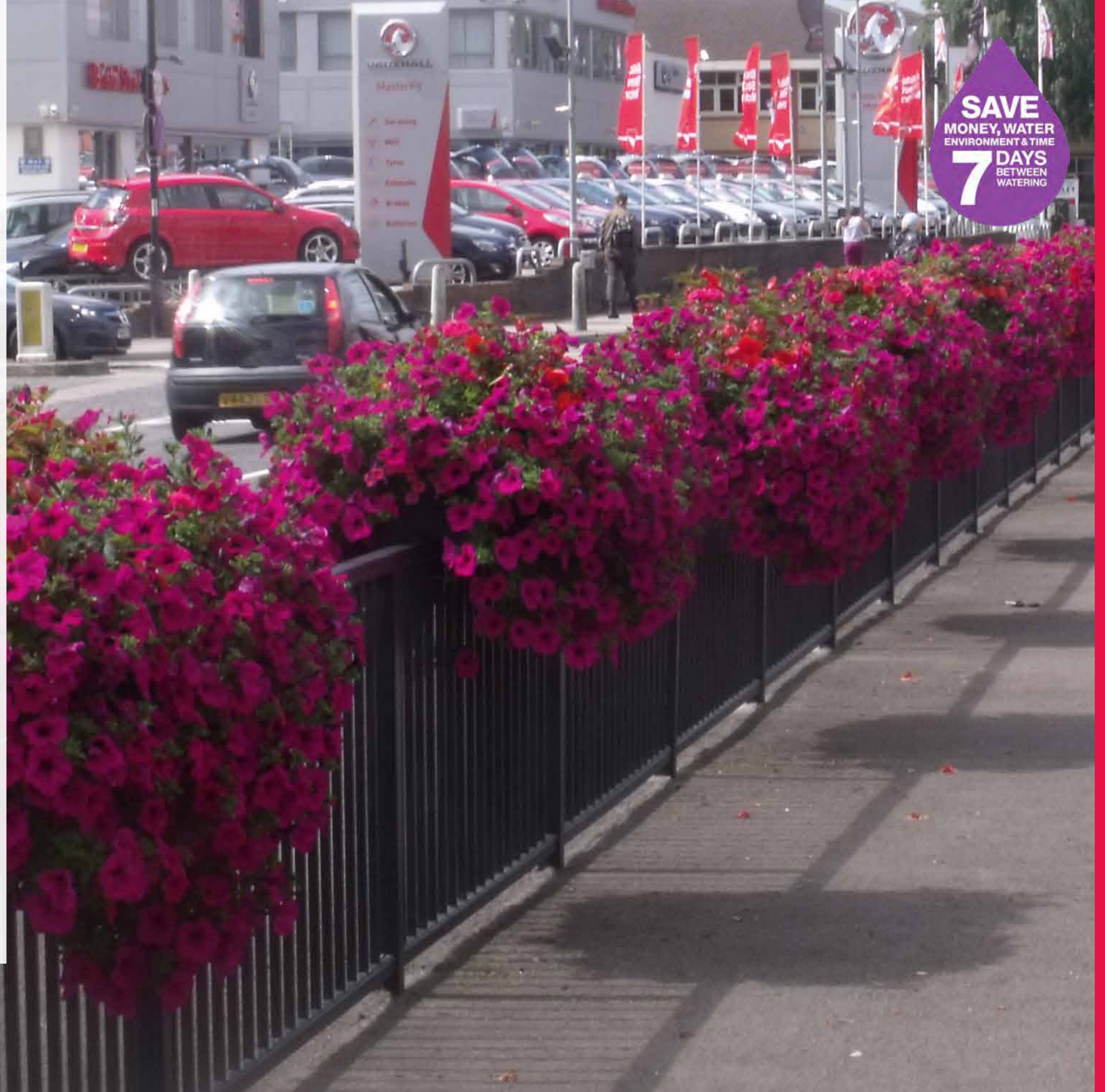

SAVE
MONEY, WATER
ENVIRONMENT & TIME
7 DAYS
BETWEEN
WATERING

hanging baskets

bringing colour to your high streets

Easily fitted, our baskets are available in four standard sizes and in a wide range of colours to blend in with your own scheme.

With a choice of brackets available (see pages 22-23) our Hanging Baskets are the perfect way of bringing colour to your streets.

Our special low maintenance features enables you to water and feed plants easily.

Plantscape's thoughtful innovation in design lets Mother Nature do all the work, providing fuss-free floral displays.

easy watering

Our solution of having a hole at the bottom of each chain leg makes watering simple and improved air circulation ensures healthy plants in the height of summer.



Beverley In Bloom



Variety of brackets and fixings available - Please see pages 22-23 for more information.

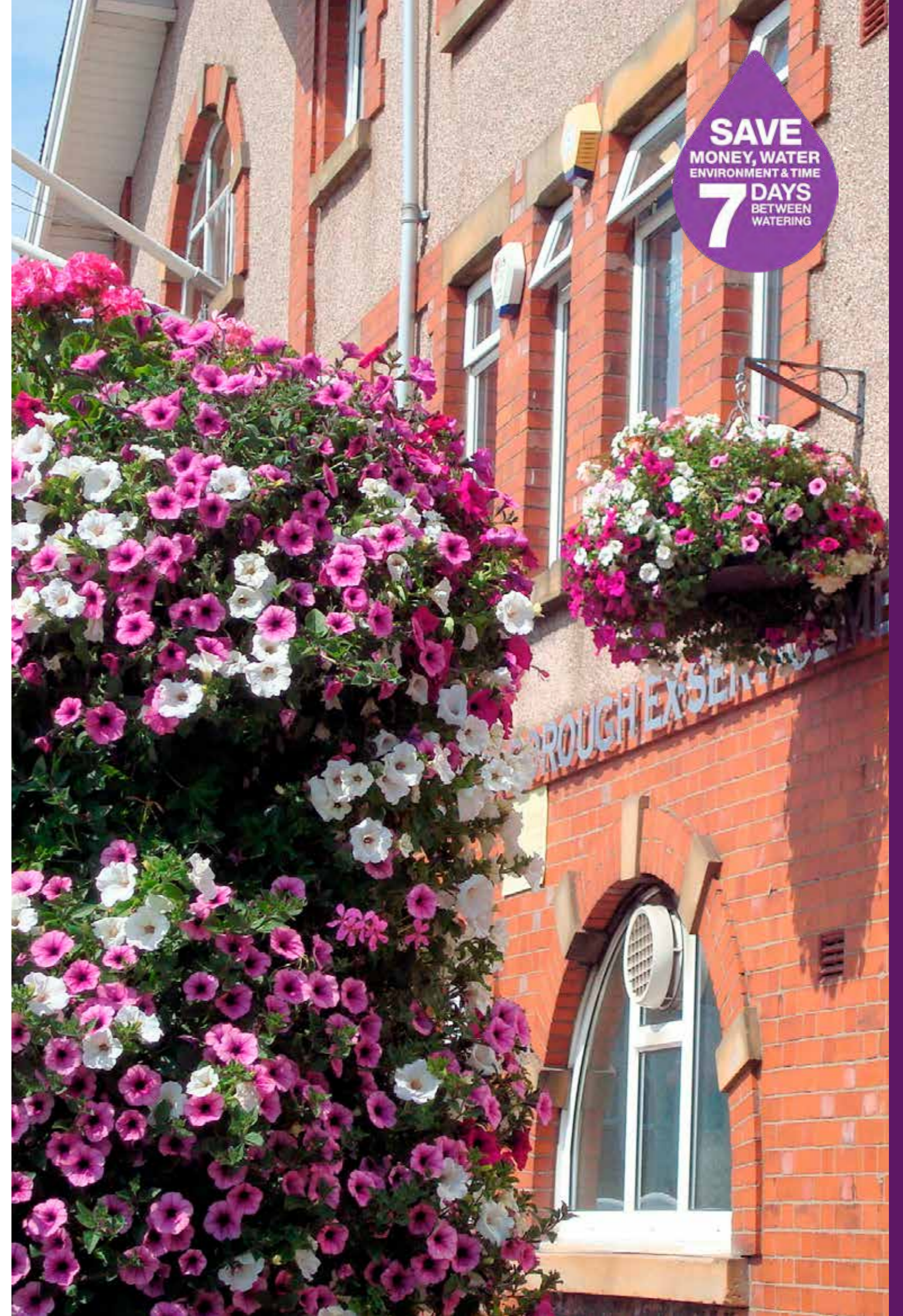

Hanging Baskets (Please see pages 26 - 27 for brackets)

7 DAYS



Specification:

- 430mm x 430mm x 255mm
- Water reservoir capacity 12 litres
- Compost capacity 12 litres
- For chain suspension

REF: PCH17/CONTRACTOR

Benefits

- Easy accessible holes for watering & feeding
- Quick release chain for ease of filling and emptying
- Improved air circulation
- Four standard sizes 410mm, 430mm, 460mm and 510mm for chain suspension
- Available in a variety of colours

Please Note: All measurements and capacities are approximate

pole-mounted baskets

to brighten up your pole tops

Plantscape's Pole-Mounted Baskets securely fit onto the top of all standard columns and posts, perfectly complementing your hanging baskets, adding colour to your pole-tops.

Available in two standard sizes and in a variety of colours to match your colour scheme or surroundings, our Pole-Mounted Baskets incorporate our special low maintenance feature, which means they can last for days without watering, providing fuss-free floral displays.

PLANTERS
AVAILABLE TO BUY
EMPTY OR TO RENT
FULLY PLANTED

Benefits

- Easy accessible holes for watering & feeding
- Fits onto all standard columns and posts
- Two standard sizes 460mm and 590mm for column top mounting
- Available in a variety of colours

Pole-Mounted Baskets

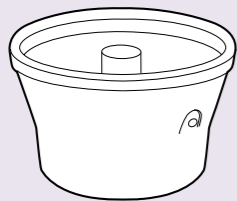

Specification:
• 460mm x 460mm x 245mm
• Water reservoir capacity 20 litres
• Compost capacity 25 litres

REF: PPU18

Specification:
• 590mm x 590mm x 290mm
• Water reservoir capacity 30 litres
• Compost capacity 52 litres

REF: PPU23

Please Note: All measurements and capacities are approximate





SAVE
MONEY, WATER
ENVIRONMENT & TIME
7 DAYS
BETWEEN
WATERING

holestar planter

lighten up your lamp-posts the quicker, safer way

Climbing the ladder to fix baskets to lamp-posts used to be a risky mission, but no longer thanks to Plantscape's innovative Holestar Planter. We've swept aside the scary routine of perching on that top rung of the ladder, trying to juggle two baskets, holding them together whilst trying to fasten them to the lamp-post.

Holestar Planters are available in three standard sizes and a variety of different colours to suit your surroundings, making them the easiest and safest way to add colour to your columns and posts. Single Holestar Planters can also be mounted to walls using our patented bracket system, which come at no extra cost.

all year round planting

Using insert liners with the Holestar Planter, means easy planting in Winter or Summer. Utilising our liners, your plants can be grown in our nursery, allowing them to become fully established before adding them to your Holestar Planter, to give an immediate change of scenery.

Benefits

- Suitable for column, post and wall mounting
- Patented system allows the planter to slot onto our custom made bracket and locks in place
- Baskets can be installed from ground level with our patented 'Easylift' system
- Ladder and chain free installation
- three standard sizes 560mm 670mm & 760mm
- Available in a variety of colours



Single Holestar Planter mounted onto wall



Lampost Holestar Planter

Holestar Planter	
	Specification: <ul style="list-style-type: none"> • 670mm x 330mm x 360mm • Water reservoir capacity 18 litres • Compost capacity 14 litres
	REF: PHP26/CONTRACTOR

Ladder Free Installation	
<p>Stage 1 The patented brackets are easily banded to any lamp-post, setting aside the old 2 finger support bracket and cable tie-on method.</p>	<p>Stage 2 With the baskets now safely and securely in place, water, stand back and admire! Baskets can be combined for pole-mounting.</p>

Please Note: All measurements and capacities are approximate

PLANTERS
AVAILABLE TO BUY
EMPTY OR TO RENT
FULLY PLANTED

elevated basket brackets

for all those finishing touches

Our design team know how important the finishing touches are, so our brackets and accessories offer an attractive range of ornamental and practical designs to complement all your hanging displays.

Strong and sturdy, our brackets are made from the finest steel and can be supplied painted to your chosen colour scheme, galvanised or even coated.

Everything you need to make those displays stand out is right here in our catalogue, but rest assured if it isn't, just tell us and we'll find it for you. We're able to make brackets for you in all shapes and sizes - let us know your requirements and we'll do the rest.



Brackets	
	Christmas Tree Bracket <ul style="list-style-type: none">• With hanging basket adaptor
	Standard Hanging Basket <ul style="list-style-type: none">• Available for all size baskets

Benefits

- Strong and sturdy brackets made from the finest steel
- Supplied and painted to your chosen style - galvanised or coated
- Available in a wide variety of standard shapes, styles and sizes
- Bespoke brackets available on request

case study

beeston BID

A thriving and busy town in Nottinghamshire is well known for being the home of Nottingham University and to Boots Pharmaceuticals. Plantscape® were contacted by Beeston BID at the end of 2011 to help improve the impact of Beeston's arterial roads and High Street retail areas. Due to the tram route expansion through the town and the disruption and demolition created by the works, Beeston was slowly being spoilt visually so Plantscape® were given the remit to draw attention away from the potential eye sores and make Beeston a more welcoming place to visit and shop.

Plantscape® supplied Beeston BID with 40 Holestair units and 140 hanging baskets with brackets to be planted to their exact specification, using a Jubilee colour theme as well as providing the required watering and maintenance for all the supplied displays.

The benefits of using Plantscape® products lies in their low maintenance features and due to the water reservoir system, which allows them to go for days without the need to be watered, and thus allowing us to provide fantastic displays for Beeston with minimal fuss and disturbance.

A representative from Beeston BID said "Our first ever hanging basket and lamp post scheme was a huge success. Beeston BID paid for 180 hanging baskets and lamp posts throughout the town to add a bit of colour to the shopping environment. The colour theme for 2012 was Jubilee to follow the celebration of all things British for this year. Many businesses have said that customers were really impressed with the baskets and that they really added something to the street scene. We are hoping to expand the number of baskets next year so more businesses feel the benefit of the scheme.

We would like to thank Beeston BID for allowing us to work with them over the last 12 months and we are already working with them to expand on the 2012 displays to bring even more colour and beauty to Beeston Town Centre for years to come.



Benefits

- Available in all types of timber
- Also available in Brushed or Polished Stainless Steel & Coated Mild Steel
- Made to suit our Square Planters (PET & PMS) and Window Boxes (PWB)



ROLEX

PLANTERS
AVAILABLE TO BUY
EMPTY OR TO RENT
FULLY PLANTED

box clevers

bringing vibrant life to public areas

Our polyethylene planters offer heavy durability and complete practicality, but when combined with style and elegance of wood or stainless steel they really do look something special.

The Plantscape® Box Clever is a purpose made, cladding system that simply sits over our square planters or window boxes, giving you the low maintenance benefits of polyethylene but the stunning appearance of metal or wood.

Available in sizes and finishes to suit your requirements, popular choices include brushed or polished stainless steel, powder coated mild steel and timber. Sleek and contemporary or traditional and sophisticated, rest assured we have a Box Clever to beautifully compliment your environment.



Wooden Box Clever

Box Clevers

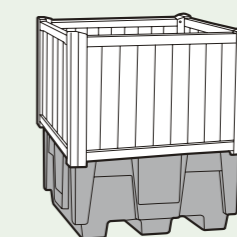

- Wooden Specification:**
- Sizes available to suit your requirements
- REF: PBC1
- Stainless Steel Specification:**
- Sizes available to suit your requirements
- REF: PBC2

interlocking bedding planters

our revolutionary concept in decorative bedding planters

Plantscape's modular Interlocking Bedding Planters, not only gives you an endless choice of creative layouts, but also makes the installation process, quicker, simpler and more effective.

Our revolutionary lightweight bedding planters can be prepared at our nursery in advance, allowing plants to become established, and then with minimum effort transported in manageable sections to your location.

Once on site the modular system allows for easy lifting and positioning, which means no more hours of planting in potentially dangerous locations. At the end of the season, planters can simply be returned to the nursery to be re-planted.

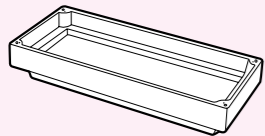
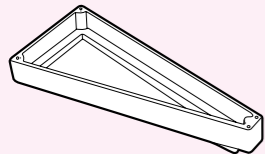
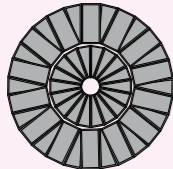
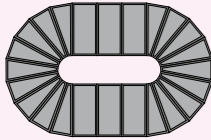
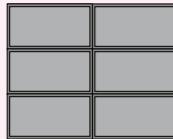
Interlocking Bedding Planters	
	<p>Specification:</p> <ul style="list-style-type: none"> • 1265mm x 540mm x 240mm • Water reservoir capacity 32 litres • Compost capacity 74 litres <p>REF: PBPR1</p>
	<p>Specification:</p> <ul style="list-style-type: none"> • 1265mm x 540mm x 240mm • Water reservoir capacity 16 litres • Compost capacity 37 litres <p>REF: PBPT1</p>
Example Layouts	
	<p>Specification:</p> <ul style="list-style-type: none"> • 5000mm x 5000mm <p>Example consists of:</p> <ul style="list-style-type: none"> • 14 No. PBPR1 (Rectangle) • 32 No. PBPT1 (Triangle)
	<p>Specification:</p> <ul style="list-style-type: none"> • 4840mm Length <p>Example consists of:</p> <ul style="list-style-type: none"> • 6 No. PBPR1 (Rectangle) • 18 No. PBPT1 (Triangle)
	<p>Specification:</p> <ul style="list-style-type: none"> • 2520mm x 1640mm <p>Example consists of:</p> <ul style="list-style-type: none"> • 6 No. PBPR1 (Rectangle)

Please Note: All measurements and capacities are approximate



**PLANTERS
AVAILABLE TO BUY
EMPTY OR TO RENT
FULLY PLANTED**

Benefits

- Lightweight design allows for easy transportation, lifting and positioning
- Modular interlocking system allows for a wide choice of creative layouts
- Planters can be prepared off site, which means no more planting in potentially dangerous locations
- Low maintenance design means planters can go for days without watering

SAVE
MONEY, WATER
ENVIRONMENT & TIME
7 DAYS
BETWEEN
WATERING



flower towers - square base

uplifting and enticing displays!

Bringing a real dash of colour to any entrance, precinct or city centre, Plantscape's Flower Towers offer both durability and flexibility.

Available in a wide range of colours, our flower towers are perfect for displaying sponsorship, advertising and logos. Our design and advisory service enable us to meet your exact specification.

The Plantscape® Flower Tower is well made, tough and easily transportable, but we'll not only deliver them to your location but we'll also set them in place for you as part of our service.

The low maintenance design feature of all our planters means that they can go for days before re-watering, so you get maximum impact for the minimum effort.

Benefits

- Durable, tough, well-made and easy to move with a hand pallet truck
- Ideal for displaying company logos, sponsorship and advertising
- Low maintenance - all our planters can go for days without watering
- Ideal for shopping centres and large feature planting
- Available in 1, 2, 3 and 4 tier baskets up to 2560mm in height, with a standard base size of 1000mm sq
- Available in a variety of colours

PLANTERS
AVAILABLE TO BUY
EMPTY OR TO RENT
FULLY PLANTED



1 tier Square Base Flower Towers developing in nursery

Flower Tower - Square Base

<p>One Tier</p>	<p>Two Tier</p>	<p>Three Tier</p>	<p>Four Tier</p>	<p>One Tier Specification:</p> <ul style="list-style-type: none"> • 1000mm x 1000mm x 730mm • Water reservoir capacity 395 litres • Compost capacity 400 litres <p>REF: PMS1</p>
<p>Two Tier Specification:</p> <ul style="list-style-type: none"> • 1000mm x 1000mm x 1400mm • Water reservoir capacity 450 litres • Compost capacity 452 litres <p>REF: PMS2</p>				
<p>Three Tier Specification:</p> <ul style="list-style-type: none"> • 1000mm x 1000mm x 1920mm • Water reservoir capacity 470 litres • Compost capacity 477 litres <p>REF: PMS3</p>				
<p>Four Tier Specification:</p> <ul style="list-style-type: none"> • 1000mm x 1000mm x 2560mm • Water reservoir capacity 515 litres • Compost capacity 573 litres <p>REF: PMS4</p>				

Please Note: All measurements and capacities are approximate

flower towers - circular base

make the most of the space you've got!

Plantscape's Flower Towers with a circular base are perfect for your high street or shopping precinct. Available in 1, 2 and 3 tier baskets they're ideal for when space is at a premium.

The Flower Tower can be produced in a wide range of colours to suit your own colour scheme, and are perfect for displaying sponsorship, advertising and logos. Our design and advisory service enable us to meet your exact specification.

Durable, tough and easily transportable, we not only deliver them to your location, but as part of our service we'll even set them in place for you.

The special low maintenance feature on this Flower Tower not only allows for easy feeding and watering, but the in-built water reservoir system means that your planters can go for days without watering, saving you both time and money.



Benefits

- Durable, tough, well-made and easy to move with a hand pallet truck
- Ideal for displaying company logos, sponsorship and advertising.
- Low maintenance - all our planters can go for days without watering
- Ideal for shopping centres and large feature planting
- Available in 1, 2 and 3 tier baskets up to 1680mm in height, with a standard base size of 815mm sq
- Available in a variety of colours



1 tier Circular Base Flower Towers



SAVE MONEY, WATER ENVIRONMENT & TIME
7 DAYS BETWEEN WATERING

PLANTERS AVAILABLE TO BUY EMPTY OR TO RENT FULLY PLANTED

Flower Tower - Circular Base		
 One Tier	 Two Tier	 Three Tier
<p>One Tier Specification:</p> <ul style="list-style-type: none"> • 815mm x 815mm x 460mm • Water reservoir capacity 60 litres • Compost capacity 180 litres <p>REF: PFT1</p>		
<p>Two Tier Specification:</p> <ul style="list-style-type: none"> • 815mm x 815mm x 1200mm • Water reservoir capacity 79 litres • Compost capacity 214 litres <p>REF: PFT2</p>		
<p>Three Tier Specification:</p> <ul style="list-style-type: none"> • 815mm x 815mm x 1680mm • Water reservoir capacity 89 litres • Compost capacity 239 litres <p>REF: PFT3</p>		

Please Note: All measurements and capacities are approximate



flower towers - octagonal base

colourful displays from any angle!

Eye-catching and ideal for when space is limited the octagonal base Flower Tower is the perfect way to brighten up your streets and shopping precincts.

Available in a wide range of colours, our Flower Towers are a great way to display advertising, logos and sponsorship. Our in-house design and advisory services means when it comes to making your planters stand out from the crowd we can meet your exact specification.

The Plantscape® Flower Tower is well made, tough and easily transportable, but we'll not only deliver them to your location but we'll also set them in place for you as part of our service.

The special low maintenance feature on this Flower Tower not only allows for easy feeding and watering, but the in-built water reservoir system means that your planters can go for days without watering, saving you both time and money.

PLANTERS
AVAILABLE TO BUY
EMPTY OR TO RENT
FULLY PLANTED



Benefits

- Durable, tough, well-made and easy to move with a hand pallet truck
- Ideal for displaying company logos, sponsorship and advertising.
- Low maintenance - all our planters can go for days without watering
- Ideal for shopping centres and large feature planting
- Available in 1, 2, 3 and 4 tier baskets up to 2560mm in height, with a standard base size of 1200mm sq
- Available in a variety of colours

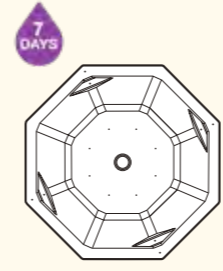
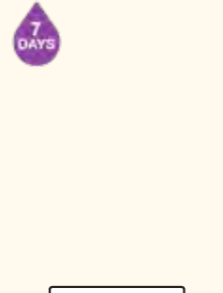

Octagonal Base Flower Tower with winter planting

SAVE
MONEY, WATER
ENVIRONMENT & TIME
7 DAYS
BETWEEN
WATERING

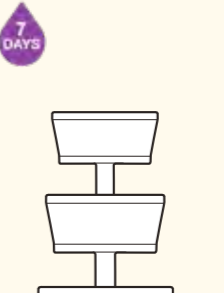
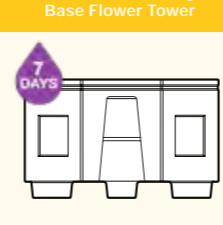
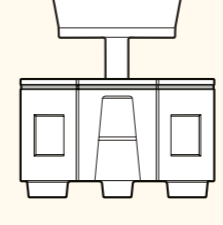
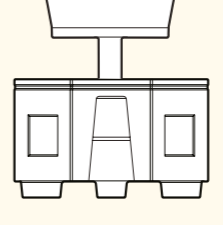
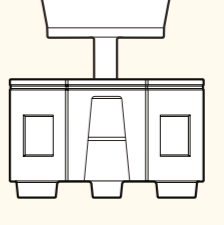
Flower Tower - Octagonal Base			
 <p>Plan elevation of Octagonal Base Flower Tower</p>	 <p>One Tier</p>	 <p>Two Tier</p>	 <p>Three Tier</p>
 <p>Four Tier</p>	 <p>Two Tier</p>	 <p>Three Tier</p>	 <p>Four Tier</p>
<p>One Tier Specification:</p> <ul style="list-style-type: none"> • 1200mm x 1200mm x 730mm • Water reservoir capacity 395 litres • Compost capacity 500 litres <p>REF: POCT1</p>			
<p>Two Tier Specification:</p> <ul style="list-style-type: none"> • 1200mm x 1200mm x 1400mm • Water reservoir capacity 450 litres • Compost capacity 552 litres <p>REF: POCT2</p>			
<p>Three Tier Specification:</p> <ul style="list-style-type: none"> • 1200mm x 1200mm x 1920mm • Water reservoir capacity 470 litres • Compost capacity 577 litres <p>REF: POCT3</p>			
<p>Four Tier Specification:</p> <ul style="list-style-type: none"> • 1200mm x 1200mm x 2560mm • Water reservoir capacity 515 litres • Compost capacity 673 litres <p>REF: POCT4</p>			

Please Note: All measurements and capacities are approximate

eye-full towers

towering beauty - as high as you want it

Impressive and extremely versatile, Plantscape's Eye-Full Towers are aptly named. With up to five tiers of baskets on a multi-level platform, these planters add a dazzling vertical pillar of colour to streets and public places.

Our patented water weir system means water goes in at just one point and is stored in a series of wells, allowing days between watering.

Available in a variety of colours and as 2, 3, 4 or 5 tiers, these planters are perfect for creating eye-catching displays when space is at a minimum.

2 tier Eye-Full Towers developing in our nursery



Benefits

- Ideal for displaying company logos, sponsorship and advertising
- Patented water weir system, allows for easy watering and feeding and means our planters can go for days before watering
- Versatile product that can be customised
- Available in 2, 3, 4 and 5 tier baskets up to 3520mm in height
- available with the option of 1250mm square or 1500mm round bases
- Available in a variety of colours

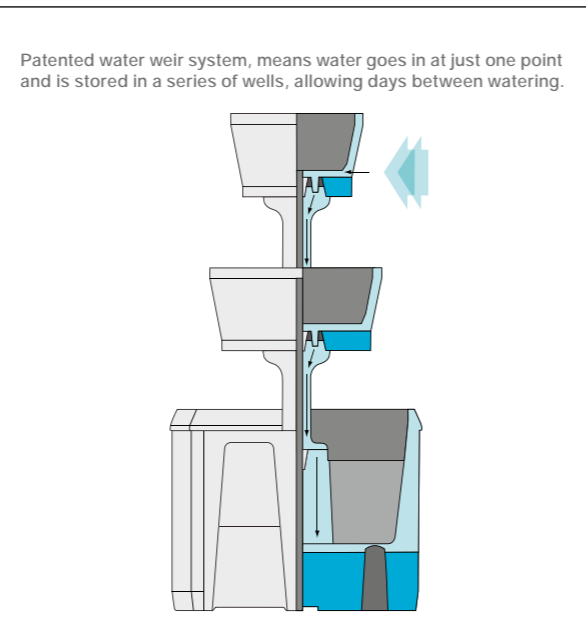

**PLANTERS
AVAILABLE TO BUY
EMPTY OR TO RENT
FULLY PLANTED**

Eye-Full Tower (Available with round or square base)				
				Two Tier Specification: • 1250mm x 1250mm x 1680mm • Water reservoir capacity 350 litres • Compost capacity 1210 litres REF: PET2R (Round Base) REF: PET2S (Square Base)
Single Tier Planter REF: PET1R (Round Base) REF: PET1S (Square Base)				
				Three Tier Specification: • 1250mm x 1250mm x 2290mm • Water reservoir capacity 365 litres • Compost capacity 1265 litres REF: PET3R (Round Base) REF: PET3S (Square Base)
Two Tier	Three Tier	Four Tier	Five Tier	
				Four Tier Specification: • 1250mm x 1250mm x 2900mm • Water reservoir capacity 375 litres • Compost capacity 1290 litres REF: PET4R (Round Base) REF: PET4S (Square Base)
				Five Tier Specification: • 1250mm x 1250mm x 3520mm • Water reservoir capacity 405 litres • Compost capacity 1345 litres REF: PET5R (Round Base) REF: PET5S (Square Base)
Dimensions & capacities given are based on the square base display				

Please Note: All measurements and capacities are approximate.

SAVE
MONEY, WATER
ENVIRONMENT & TIME
7 DAYS
BETWEEN
WATERING



PLANTERS
AVAILABLE TO BUY
EMPTY OR TO RENT
FULLY PLANTED

colour-fall towers

flowering fountains of colour

Eye-catching and versatile, Plantscape's Colour-Fall Towers are an impressive way to brighten up any street or public place.

Available in a variety of colours and as 2, 3, 4, 5 or 6 tiers, these planters are perfect for creating dazzling displays when space is at a minimum. 7 and 8 tiers also available as specials.

low maintenance

Our patented water weir system means water goes in at just one point and is stored in a series of wells, allowing days between watering.





6 tier Colour-Fall Towers developing in our nursery

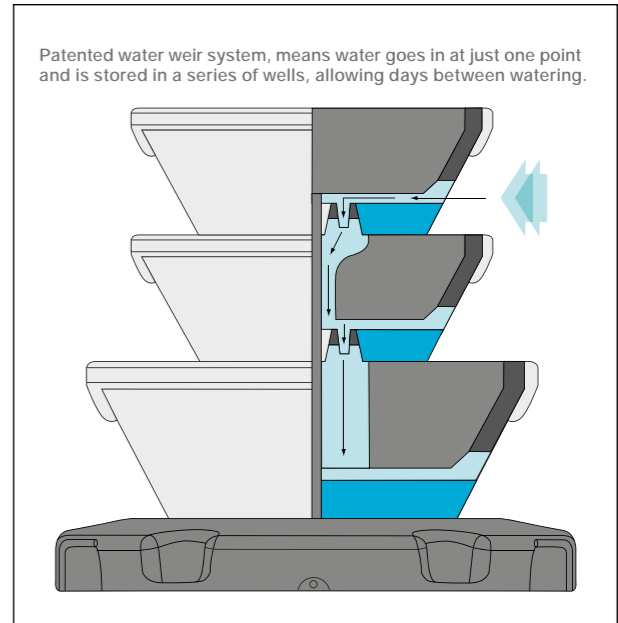

Benefits

- Patented water weir system, allows for easy watering and feeding and means our planters can go for days before watering
- Available in 2, 3, 4, 5 and 6 tier baskets up to 1495mm in height, with a standard base size of 1100mm diameter
- The sky's the limit - higher tiers available on request
- Available in a variety of colours

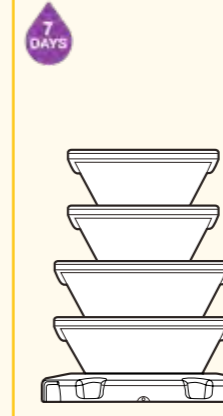
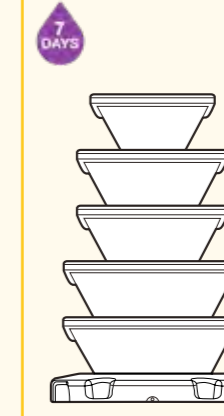

Colour-Fall Tower				
				
Two Tier	Three Tier	Four Tier	Five Tier	Six Tier
Specification: <ul style="list-style-type: none"> • 1100mm x 1100mm x 645mm • Water reservoir capacity – 100 litres • Compost capacity 120 litres • Unit comprises of: Base Planter + 2 Large Tiers 	Specification: <ul style="list-style-type: none"> • 1100mm x 1100mm x 855mm • Water reservoir capacity – 115 litres • Compost capacity 160 litres • Unit comprises of: Base Planter + 2 Large Tiers + 1 Middle Tier 	Specification: <ul style="list-style-type: none"> • 1100mm x 1100mm x 1065mm • Water reservoir capacity – 130 litres • Compost capacity 200 litres • Unit comprises of: Base Planter + 2 Large Tiers + 2 Middle Tiers 	Specification: <ul style="list-style-type: none"> • 1100mm x 1100mm x 1275mm • Water reservoir capacity – 140 litres • Compost capacity 220 litres • Unit comprises of: Base Planter + 2 Large Tiers + 2 Middle Tiers + 1 Top Tier 	Specification: <ul style="list-style-type: none"> • 1100mm x 1100mm x 1495mm • Water reservoir capacity – 150 litres • Compost capacity 240 litres • Unit comprises of: Base Planter + 2 Large Tiers + 2 Middle Tiers + 2 Top Tiers
REF: PCFT2	REF: PCFT3	REF: PCFT4	REF: PCFT5	REF: PCFT6

Please Note: All measurements and capacities are approximate

Higher tiers available on request

pathway planter

add a dash of colour to any corner!

Plantscape's Pathway Planters are the perfect addition to any public space. Providing not only fabulous floral displays these versatile and durable planters are also great for displaying sponsorship, logos and advertising, making these the planters that pay for themselves.

Durable, tough and resistant to vandalism, the Pathway Planter is made from 100% recyclable materials and is available in a wide range of colours to suit your colour scheme.

The low maintenance design feature of all our planters means that they can go for days before re-watering, giving you maximum impact for minimum effort.

The Pathway Planter is also ideal for use in schools as part of horticultural therapy programs, where sensory stimulation is provided to children by planting fragrant and colourful herbs and plants.

PLANTERS
AVAILABLE TO BUY
EMPTY OR TO RENT
FULLY PLANTED

Benefits

- Made from 100% recyclable materials
- Tough polyethylene makes it extremely durable and resistant to vandalism
- Low maintenance - all our planters can go for days without watering
- Ideal for displaying company logos, sponsorship and advertising
- Ideal for use in schools as part of horticultural therapy programs
- Available in a variety of colours

Pathway Planter

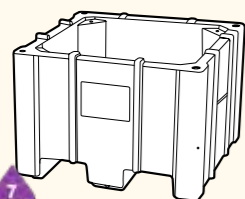

Specification:
• 700mm x 700mm x 500mm
• Water reservoir capacity 139 litres
• Compost capacity 80 litres

REF: PPWP



Please Note: All measurements and capacities are approximate





case study

kings cross

Kings cross, an iconic railway station in the centre of London known throughout the world as one of the busiest transport hubs in England.

Plantscape® were approached by network rail to help with the flow of passengers throughout the Olympic games - using the station as a hub for their onward journey! In total 10 large Eye-Full base planters were used with a stainless steel shroud planted using hardy plants, giving a very modern and robust look, the benefit of this product lies in its low maintenance features due to the water reservoir system which allow for it to go days sometimes weeks between watering's.

From Plantscape's initial site survey to the installation date everything that needed planning was undertaken by our specialist team, resulting in a seamless supply and install, working through the night making disruption to the public and surrounding properties a minimum.

Plantscape® would love to get involved with your future projects with an initial telephone call being all it takes!



Benefits

- Made from 100% recyclable materials
- Tough polyethylene makes it extremely durable and resistant to vandalism
- At 700mm square by 500mm high the vegee-table is perfect for use by children as they can reach across the entire planter
- Perfect for growing everything from potatoes, carrots and onions, to peas, runner beans and tomatoes
- Ideal for use in schools as part of horticultural therapy programs - providing sensory stimulation using fragrant and colourful herbs and plants
- Comes with a 5 year guarantee!

bringing education back to it's roots!

With all the distractions children have today, the Vegee-table is here to entice and encourage them to get their hands dirty and enjoy nature at its best.

Designed specifically for children, the Vegee-table can grow a variety of seasonal vegetables, even in the smallest of spaces.

education with a difference

Your pupils will learn elements of the national curriculum including seed germination and growth. Unlike many of the planters on the market today, the Vegee-table features Plantscape's patented watering system. This means the vegee-table will survive several days without watering, which will enable your plants to survive school holidays and weekends.

vegee-table starter kits



Vegee-table

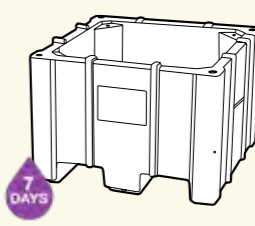

Specification:
• 700mm x 700mm x 500mm
• Water reservoir capacity 70 litres
• Compost capacity 80 litres

REF: PVTP1

Please Note: All measurements and capacities are approximate

Starter Kit

- 🍎 4 x vegee-table planters (available in a variety of colours)
- 🍎 4 x 80 litre bags of compost
- 🍎 2 x children's forks
- 🍎 2 x children's trowels
- 🍎 2 x pairs of gardening gloves
- 🍎 4 x packets of assorted seeds
- 🍎 + delivery included

Supplementary Kit

- 🍎 2 x vegee-table planters (available in a variety of colours)
- 🍎 2 x 80 litre bags of compost
- 🍎 1 x children's fork
- 🍎 1 x children's trowel
- 🍎 1 x pairs of gardening gloves
- 🍎 2 x packets of assorted seeds
- 🍎 + delivery included

SAVE
MONEY, WATER
ENVIRONMENT & TIME
7 DAYS
BETWEEN
WATERING



SAVE
MONEY, WATER
ENVIRONMENT & TIME
7 DAYS
BETWEEN
WATERING

case study

brailsford primary school

Brailsford primary school, a small village school in Derbyshire, wanted to bring a bit of life to their very small open space and at the same time make it educationally beneficial for their students and gardening club.

The solution... the Vegee-table. Designed specifically for children, the vegee-table can grow a variety of seasonal vegetables, even in the smallest of spaces. Allowing children to fully benefit from a truly natural education. What's more, with our patented watering system, it allows the Vegee-table to survive without watering for several days. Leaving you time to enjoy school holidays and weekends.

A win-win situation you might say. With its versatile design, it is perfect for growing everything from potatoes, carrots and onions to peas, runner beans and tomatoes. A benefit that the pupils at Brailsford Primary School are positively reaping from; in the form of their school dinners!

The Vegee-table is also ideal for use in schools as part of the horticultural therapy program. Allowing children the ability to garner social and vocational benefits from the fragrant and colourful plants and herbs they are tending to on a regular basis.

This is education with a difference.

Ideal for use in schools as part of horticultural therapy programs



tree planters

transforming public spaces

Plantscape's versatile Tree Planters are the perfect way to add instant charm to those bland corners. Durable, tough and resistant to vandalism, our Tree Planters are made from 100% recyclable materials and are available in a choice of circular or square shapes.

With their large side panels they are ideal for displaying company logos, sponsorship and advertising, and our design and advisory service is on hand to meet your exact specification. Our planters can be supplied in a variety of colours and finishes to suit your environment.

low maintenance

The built in reservoir feature, means our planters can go for days before watering, making it both versatile and easy to maintain.

Benefits

- Low maintenance - the built in reservoir feature means planters can go for days before watering
- Choice of 2 shapes - square or round
- Ideal for displaying company logos, sponsorship and advertising
- Easily moved with a hand pallet truck
- Available in a variety of colours

Tree Planters

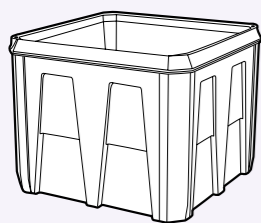

Specification:
 • 1250mm x 1250mm x 1000mm
 • Water reservoir capacity 330 litres
 • Compost capacity 1120 litres

REF: PTPS (Square)

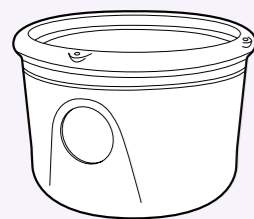

Specification:
 • 1500mm x 1500mm x 1000mm
 • Water reservoir capacity 300 litres
 • Compost capacity 600 litres

REF: PTPR (Round)

Please Note: All measurements and capacities are approximate



**PLANTERS
 AVAILABLE TO BUY
 EMPTY OR TO RENT
 FULLY PLANTED**

SAVE
MONEY, WATER
ENVIRONMENT & TIME
7 DAYS
BETWEEN
WATERING



PLANTERS
AVAILABLE TO BUY
EMPTY OR TO RENT
FULLY PLANTED

manchester planters

the planters that pay for themselves!

Providing excellent advertising possibilities, Plantscape's Promotional Planters not only add beauty to your streets and public places, but can also generate income.

Available in a variety of colours and with large panels suitable for advertising campaigns, sponsorship and company logos, the Manchester Promotional Planter provides not only eye-catching floral displays but also allows excellent opportunities to put your company name in all the right places.

low maintenance and secure

The built in reservoir feature on the Manchester Planter, means it can go for days before watering, whilst our security brackets protect from theft, making it easy to maintain and extremely versatile.

Benefits

- Low maintenance - the built in reservoir feature means planters can go for days before watering
- Large panels suitable for advertising, sponsorship & company logos
- Security brackets available
- Easily moved with a hand pallet truck
- Available in a variety of colours

Manchester Planter

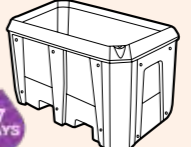
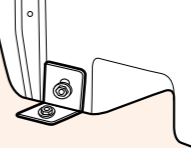
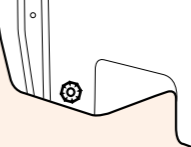
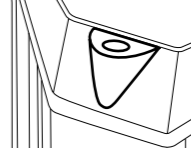
	<p>Specification:</p> <ul style="list-style-type: none"> • 1250mm x 750mm x 750mm • Water reservoir capacity 349 litres • Compost capacity 500 litres <p>REF: PMP1</p>
	<p>Security Brackets</p>
	<p>Drain and Fixing Holes</p>
	<p>Easy-access Watering</p>

Please Note: All measurements and capacities are approximate

pedal park

the attractive way to park your bike!

Plantscape's Pedal Park Planter is a stylish, practical and secure way to park your bicycle, adding a splash of colour to any civic surrounding.

The environmental advantages of cycling are endless, but for the two wheeled traveller finding a safe and secure place to park can be a real problem. Locked onto barriers and railings, bikes can often leave streets looking untidy, but the Pedal Park Planter enables neatly parked bicycles to keep streets tidy, whilst at the same time creating an eye-catching floral display.

low maintenance and secure

With integral security staples, the Plantscape® Pedal Park is well protected against theft and vandalism. The built in water reservoir system in all of our planters mean they can go for days without watering.



Pedal Park	
	<p>Specification:</p> <ul style="list-style-type: none"> • 1250mm x 750mm x 750mm • Water reservoir capacity 349 litres • Compost capacity 500 litres • Standard pedal park comes with double cycle rack to one side <p>REF: PPP1</p>
	Security Brackets
	Drain and Fixing Holes
	Easy-access Watering

Please Note: All measurements and capacities are approximate



- ### Benefits
- Practical and secure way to park your bicycle
 - Low maintenance - the built in reservoir feature means planters can go for days before watering
 - Large panels suitable for advertising, sponsorship & company logos
 - Standard pedal park comes with double cycle rack to one side - optional racks for other side available on request
 - Security brackets available
 - Available in a variety of colours

planter seats

the modular planting system that can grow with your needs

Plantscape's modular Planter Seats and barrier system offer you an endless choice of creative layouts for your floral displays, and are available in a wide variety of colours.

Ideal for providing flower surrounded seating or protective surrounds for trees and signs, these durable, vandal resistant units can also be used as informal barriers for movement control by simply removing the seats.

bespoke planter seats

If polyethylene planter seats aren't your thing, then why not consider wood. With the help of our efficient production team, bespoke planter seats can be built to your exact specification. Combining high quality craftsmanship and traditional materials gives a sophisticated look to any public place. Committed to the environment, we only work with timber from sustainable sources, and is available in a wide choice of finishes.



Bespoke wooden Planter Seat

Endless layout opportunities:

- A - remove the seat and the planter seats can be interlocked
- B - create protective surrounds, ideal for trees and signs by placing two PPS1 planters together
- C - for larger areas, use four PPS1 planters to create an alternative surround

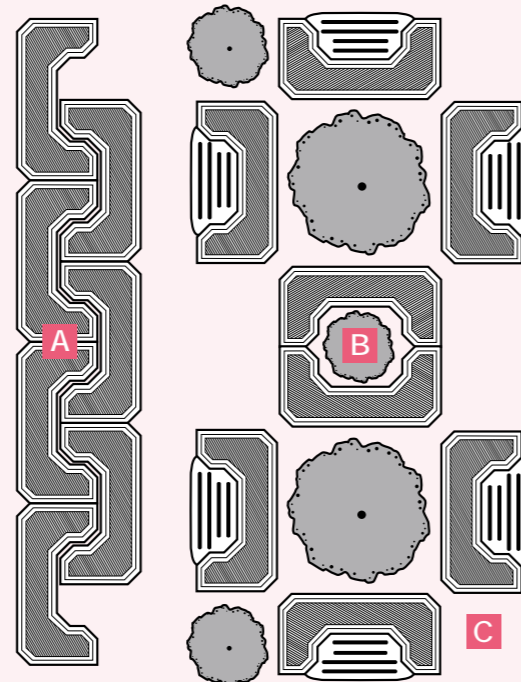

Example layout configurations

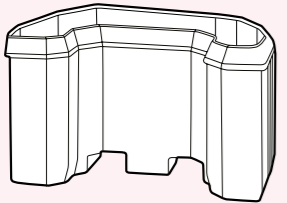
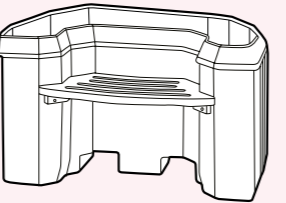
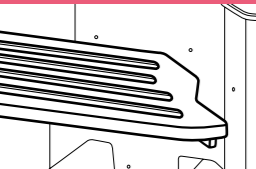
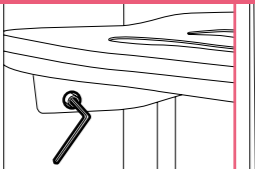
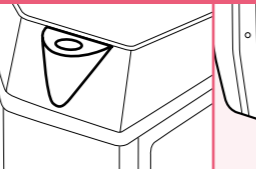
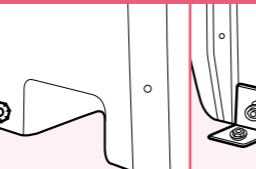
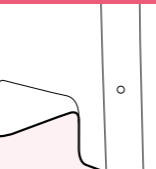
<p>Planter Seat</p>  <p>Specification:</p> <ul style="list-style-type: none"> • 1250mm x 630mm x 750mm • Water reservoir capacity 120 litres • Compost capacity 205 litres <p>REF: PPS1</p>		 <p>Specification:</p> <ul style="list-style-type: none"> • 1250mm x 630mm x 750mm • Water reservoir capacity 120 litres • Compost capacity 205 litres <p>REF: PPS2</p>	
<p>Features</p>			
 <p>Removable Seats</p>	 <p>Allen Key Fixing</p>	 <p>Easy-access Watering</p>	 <p>Drain and Fixing Holes</p>
		 <p>Security Brackets</p>	

Please Note: All measurements and capacities are approximate

Benefits

- Ideal for floral surround seating, protective surrounds and informal barriers
- Bespoke wooden planter seats can also be made to your exact specifications
- Modular system, with endless layout opportunities
- Removable seats for flexibility
- Easy accessible holes for watering & feeding
- Handy drain and fixing holes
- Security brackets available
- Available in a variety of colours

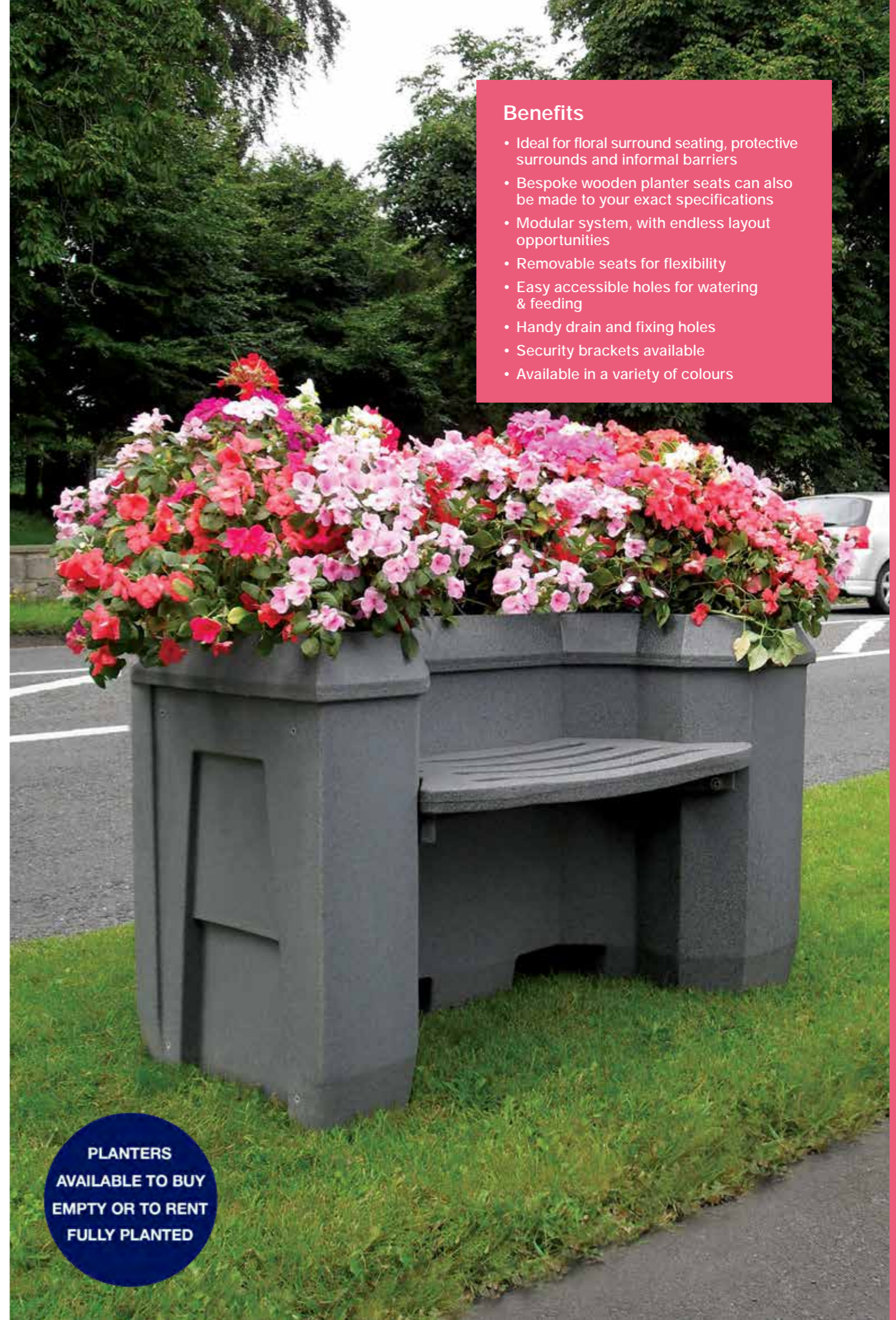

PLANTERS
AVAILABLE TO BUY
EMPTY OR TO RENT
FULLY PLANTED



case study

gold award beverley in bloom

Sunday Times listed market town wins In Bloom Gold with Plantscape displays

The market town of Beverley, named last year by the Sunday Times as one of the best places to live in Northern England, has won a Gold Yorkshire in Bloom award in its first year of enjoying Plantscape's dazzling array of hanging baskets!

Town clerk Helen Watson describes the displays as 'stunning' – and she knows what she's talking about as she's also an In Bloom judge!

In fact, she is so impressed she is already poised over the summer 2020 order form and is keen to trial Plantscape's new range of bee-friendly planters.

Until this summer, Beverley floral fans created and watered their own displays using Plantscape's empty hanging baskets – but, having found out about its unique seven-day-watering planters, Helen decided to give the full service offering a whirl.

"I had done a bit of research and looked around at some of the planters that Plantscape did last year, and they looked lovely. And the once-a-week watering system is more sustainable, both environmentally and workwise," she explained.

The council offered shops, pubs, cafes and businesses a chance to pay for the 80 baskets at a subsidised rate to help boost the town's chances in the Beverley and Yorkshire in Bloom competitions.

"The Plantscape planters have been a riot of beautiful colours, and grown so well. They really do look fabulous. It's evident that they are well cared for and maintained. The plants have grown over the baskets covering all the plastic and they look stunning," she added.

"Many residents and visitors have commented on how lovely the flowers all look around the town as they shop or enjoy a meal or a drink and our councillors are very pleased with the response. The baskets with their bright colours and trailing plants certainly make me happier."

Benefits

- High quality materials for a natural and sophisticated finish
- All timber comes from sustainable sources
- Internal waterproof membrane
- Planters can be made to specific requirements
- Available in 3 standard sizes, 1000mm sq., 1250mm sq. and 1500mm sq. - bespoke sizes available on request
- Choice of 4 standard timber finishes with bespoke colours available on request

wooden planters for a natural, sophisticated finish

Combining high quality craftsmanship and traditional materials means our Wooden Planters give a sophisticated look to any street or public place.

Our high manufacturing standards means maximum strength and durability. Before being stained and painted in your choice of colour, our Wooden Planters are carefully sanded and prepared, and an internal waterproof membrane comes as standard.

With a choice of three standard sizes and four finishes, we also offer a bespoke service, making them ideal for corporate promotions and sponsors.

committed to the environment

We don't compromise with our wood suppliers, the only timber we work with comes from sustainable sources - nothing else will do.

Wooden Planters	Finishes
 <p>Specification:</p> <ul style="list-style-type: none"> • 1000mm x 1000mm x 790mm • Compost capacity 750 litres • 1250mm x 1250mm x 790mm • Compost capacity 1172 litres • 1500mm x 1500mm x 790mm • Compost capacity 1688 litres 	 <p>REF: PWP (Softwood)</p>
	 <p>REF: PWP (Tanalised Softwood)</p>
	 <p>REF: PWP (Sapele Hardwood)</p>
	 <p>REF: PWP (Iroko Hardwood)</p>

Please Note: All measurements and capacities are approximate

**PLANTERS
AVAILABLE TO BUY
EMPTY OR TO RENT
FULLY PLANTED**

Benefits

- 100% recyclable and sourced only from sustainable forests
- Class 1 durability – making it perfect for outdoor use
- Superior resistance to the effects of UV exposure meaning the woods natural appearance is retained for longer
- Paints and varnishes last 3 or 4 times longer, reducing maintenance costs
- Internal waterproof membrane
- Planters made to any size to suit your requirements

accoya® planters

wood without compromise!

Accoya® wood is an extensively researched and proven “new wood species” with ultra high performance properties that match or exceed the very best tropical hardwoods but is grown in just 25 years.

Accoya® wood can be used with absolute confidence in external applications. Where quality, durability, dimensional stability and reliability matter, Accoya® wood is the natural choice.

Superior quality and kind to the environment!

Made only from sustainably sourced wood, Accoya® wood is non-toxic, and because of it's stability is exceptionally easy to maintain. It's superior resistance to the effects of UV exposure means that not only is the natural appearance of the wood retained for longer, but the lifespan of paints and varnishes can be increased by up to four times, saving both environmental and financial costs.



60 YEAR MINIMUM SERVICE LIFE



CLASS 1 DURABILITY



DIMENSIONAL STABILITY



100% NON TOXIC

PLANTERS
AVAILABLE TO BUY
EMPTY OR TO RENT
FULLY PLANTED

case study

nuneaton wooden planters

A regular contender in the Britain in Bloom competition, Nuneaton is renowned for taking great pride in bringing colour and beauty to the town.

Our Wooden Planters are a popular addition to the streets of Nuneaton through regular purchase by Warwickshire County Council; a partnership that has spanned over many years.

We are committed to the environment, that's why all our Wooden Planters are made from high quality timber derived from a sustainable source.

It doesn't stop there, our Wooden Planters are built by highly skilled craftsmen and are available in four standard timber finishes and three standard sizes. But as always Plantscape® will always go that bit further to make our planters fit your specific requirements.

In this case, Warwickshire County Council requested ten Iroko Wooden Planters and asked for the timber to be left untreated in order to prompt a weathered appearance to blend in with its surroundings.



Benefits

- Made to your own specific requirements
- Brings your public spaces to life
- Finest quality materials and manufacturing methods
- Practical and efficient solutions
- Planters can be supplied on their own or fully planted



PLANTERS
AVAILABLE TO BUY
EMPTY OR TO RENT
FULLY PLANTED

bespoke planters

your ideas... our expertise!

Plantscape's planter range offers a wide and varied choice of styles - but you may well have your own ideas and we're keen to hear them. Our Bespoke Planters are made just the way you want them.

With the help of our efficient production team, a Bespoke Planter built to your own specific design can bring your public space to life in a matter of weeks. Basic, ornate, practical or downright fancy, Plantscape® have the expertise and craftsmanship to make your public space truly memorable.





castaway® planters

strength, style and durability

Plantscape's Castaway® Planters come in a variety of shapes, styles, sizes and colours and their versatility means they'll look good anywhere.

Ideal for large feature planting, these tough, yet attractive planters are designed for lasting the distance in busy public areas. Basket Trees can easily be integrated into any Castaway® Planter.

Manufactured to suit your needs and specification, large side panels make them the perfect choice for advertising, sponsorship and company logos.

Benefits

- Tough, durable and versatile
- Ideal for large feature planting
- Large panels suitable for advertising, sponsorship & company logos
- Available in a wide variety of shapes, styles, sizes and colours - bespoke sizes and colours available on request

Castaway® Planters

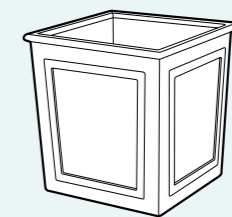

- Specification:**
- 500mm x 500mm x 500mm
• Compost capacity 125 litres
 - 650mm x 650mm x 700mm
• Compost capacity 296 litres
 - 1000mm x 1000mm x 700mm
• Compost capacity 700 litres

REF: PCA (Fluer)

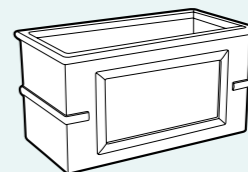

- Specification:**
- 1000mm x 400mm x 700mm
• Compost capacity 280 litres
 - 1500mm x 400mm x 700mm
• Compost capacity 420 litres
 - 2000mm x 400mm x 700mm
• Compost capacity 560 litres

REF: PCA (Sion)

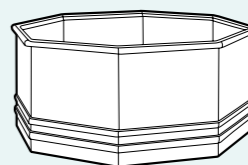

- Specification:**
- 1000mm x 1000mm x 700mm
• Compost capacity 700 litres
 - 2000mm x 2000mm x 700mm
• Compost capacity 2800 litres

REF: PCA (Chloe)

Please Note: All measurements and capacities are approximate

welcome signs

give your visitors a colourful welcome

Why not welcome visitors to your area with our wide range of signs, available in a variety of shapes, sizes and styles. Combined with our Window Box Containers (available on page 10 - 11) these fantastic floral features are the perfect way to display your identity with pride.

stand out from the crowd!

Our design and advisory service means that we can custom build your signage to meet your exact requirements and specification. From simple notices and wording to elaborate emblems and graphics our expert production team will work with you to develop a unique product range helping you to convey your own identity and message.



Signage with Window Box container

Benefits

- Welcomes visitors to your area
- Wide variety of standard sizes and styles available
- Bespoke signs custom built to suit your exact requirements
- Combine with our window box container to add eye-catching floral feature



Plantscape®
welcomes
you to...





basket trees

make the most of smaller spaces!

Hot dip galvanised and powder coated in the colour of your choice, Plantscape's long life, money saving Basket Trees won't rust or deteriorate, supplying you with a product that will be admired for many years to come.

Basket Tree's can be fixed to the ground using a variety of fixings to suit your needs from permanent fixings to socket fixings.

Available in a wide variety of standard sizes, our bespoke service means if you can't find one to fit your exact requirements, tell us the shape and sizes and leave it to us - whatever you need, we can make it.

6 Arm Basket Tree

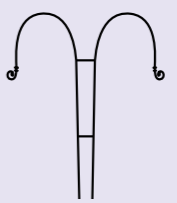
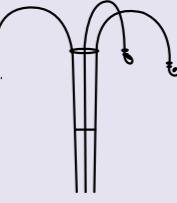
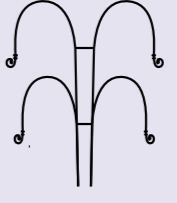
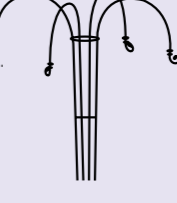
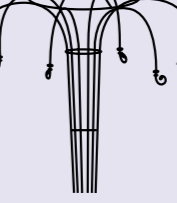

Basket Tree	
	<p>Specification:</p> <ul style="list-style-type: none"> • Two Arm Basket Tree • 2500mm x 1500mm x 3000mm • Ground Fixings 450mm <p>REF: PBT2</p>
	<p>Specification:</p> <ul style="list-style-type: none"> • Three Arm Basket Tree • 2500mm x 1500mm x 3000mm • Ground Fixings 450mm <p>REF: PBT3</p>
	<p>Specification:</p> <ul style="list-style-type: none"> • Two Tier Four Arm Basket Tree • 2500mm x 1500mm x 3000mm • Ground Fixings 450mm <p>REF: PBT2x2</p>
	<p>Specification:</p> <ul style="list-style-type: none"> • Four Arm Basket Tree • 2500mm x 1500mm x 3000mm • Ground Fixings 450mm <p>REF: PBT4</p>
	<p>Specification:</p> <ul style="list-style-type: none"> • Six Arm Basket Tree • 2500mm x 2000mm x 3000mm • Ground Fixings 450mm <p>REF: PBT6</p>

Please Note: All measurements are approximate

Benefits

- Long life - won't rust or deteriorate
- Fixed to the ground using a variety of fixings to suit your needs from permanent fixings to socket fixings
- Fits to our Eye-Full Tower base, giving the unit immense stability
- Easily dismantled for storage when not in use
- Available in a wide range of sizes, materials, colours and finishes
- Bespoke basket trees available on request

basket tree base

make the most of smaller spaces!

Our range of Basket Trees offers so many creative alternatives for attractive floral displays, so combining them with our Eye-Full Tower base gives the unit immense stability and allows your visitors to enjoy their beauty at eye level.

Easy to maintain and water, simple to move and made to the highest quality, these are an ideal way to create a colourful feature in any public space.



6 arm Basket Tree in PET1 with Wooden Box Clever

Basket Tree Base	
	Specification: • 1250mm x 1250mm x 1850mm • Water reservoir capacity 330 litres • Compost capacity 1120 litres
	REF: PET1 (Base)
	Note: Note: Tiers PBT3, PBT4, PBT2x2 & PBT6 can all be used with PET1

Please Note: All measurements and capacities are approximate



Benefits

- Easy accessible holes for watering & feeding
- Long-lasting units made from high quality material
- Hot dip powder-coated trees to stop baskets from rusting and deteriorating
- Basket trees made to fit eye-full tower base giving the unit stability
- Can be used to conjunction with our wooden planters
- Bespoke basket trees available on request

lamp post christmas trees

enjoy a totally green christmas!

Everyone loves seasonal illuminations, they provide pleasure and cheer up any location. The Plantscape® solar powered Christmas Tree with lights offers just that, but with none of the hassle.

Our completely self sufficient trees come with their own battery pack which charges throughout the day and illuminates your streets at night. Available on a rental only basis, our costs include delivery, placement, a full back up service available 7 days a week and removal at the end of the season.

Weighing no more than your summer floral displays they fit onto our standard Holestar Bracket, which means that no drilling of Lamp-Post or buildings is necessary, and because the lights are solar powered it means not only no increase in your electrical bills, but also no wiring or electrical certification is needed!

Benefits

- Solar powered - comes complete with battery pack, making them completely self sufficient and removing any need for wiring or electrical certification
- All component parts made from re-cycled materials
- Fit onto our standard Holestar brackets – no drilling required!
- Weight is the same as standard hanging basket
- Available for hire only – costs include delivery, placement, a full back up service available 7 days a week and removal
- No cutting down Christmas Trees

Lamp Post Christmas Trees



Specification:
 • 1400mm x 650mm x 320mm
 • Weight: 13kg per half unit

REF: PXT1

Please Note: All measurements are approximate



Hanging christmas trees

let there be light!

Now spread the light to even more places – with the UK's first hanging solar-powered tree.

Developed in addition to our unique and popular Solar Powered Christmas Trees for lamp posts.



Benefits

- Fits any sturdy hanging basket bracket
- Advanced solar panels
- Completely self-sufficient – no wiring or electricity bills
- In-built timer
- All component parts made from recyclable materials
- Saves time and money
- Charges even in ambient winter conditions
- Available on a rental-only basis, our costs include delivery, installation, a full seven-day back-up service and removal at the end of the season

Hanging Christmas Trees



Specification:
 • 850mm x 440mm
 • Weight: 9.5kg

REF: PXH1/Hanging

Please Note: All measurements are approximate



Plantscape's customers imagination!



colour & finishes

pick your own colour scheme!

Tough polyethylene not only makes our planters extremely durable and resistant to vandalism, it also allows our customer the choice of a wide range of colours and finishes.

Whether you want your planter to blend in with background or stand out in the crowd, we have a colour scheme to suit your needs.

Bespoke colours are available at further cost, please contact the sales team for further information.

Solid Colours

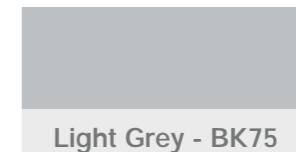
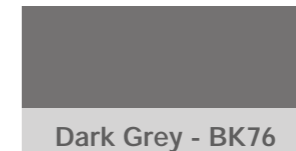
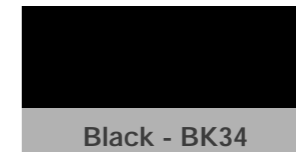

Stone Colours

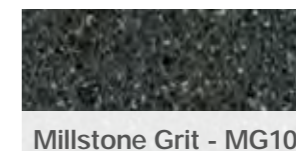

Please Note: Colours shown are a representation only and may vary slightly

for all seasons

Plantscape® all year round

Whatever the season and whatever your requirement, Plantscape® can be called upon all year round to decorate the streets near you.

Every year we supply villages, towns, cities and organisations with a splash of summer colour and we can provide a ready-made display to make an instant impact – perfect to celebrate a one-off event.

Our planters – which are available to rent ready planted-up, or to buy outright for you to mount your own display – can suit any location. You can also choose our cost-effective maintenance package.

Then, as summer turns into autumn, our winter planters will keep your community looking good until spring while for those who want to celebrate the festive period in unique style, we supply the UK's only solar powered street Christmas trees, giving a sparkling show without the hassle!





Plantscape Ltd.
7 Outrams Wharf, Little Eaton,
Derbyshire, DE21 5EL, United Kingdom
T: 0330 555 0121 (Option 4)
E: info@plantscapeuk.com
www.plantscapeuk.com

Plantscape® products in this brochure are the subject of intellectual property protection, including patent applications, registered designs and copyright/design right. In addition, certain trademarks are protected by registration, while this brochure itself is protected by copyright.

Plantscape® will take appropriate action to enforce these rights in respect of any infringement of their intellectual property.